

FREELOX RESERVE

User manual

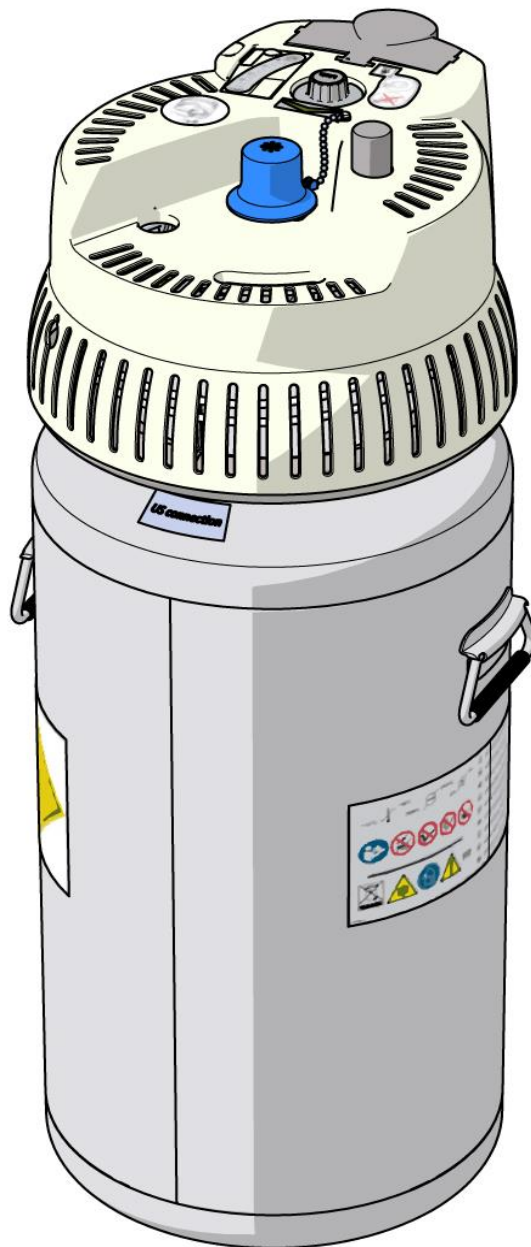

Copyright© 2017 by CryopAL
Document code: NH78459 – Revision E
October 2017 edition
English version.
Year of obtaining CE marking: 01/01/2005



Notified body: LNE GMED

All rights reserved. This document may not be reproduced in any form whatsoever, in whole or in part, without written permission from Cryopal.

This manual complies with Directive 93/42/EC concerning medical devices, as well as with IEC standard 60601-1-11 and IEC standard 60601-1-2: 2014 (version 4).

The FREELOX RESERVE device is only intended for oxygen therapy. For any questions regarding how the device works, please contact your health care provider.



CryopAL

Parc Gustave Eiffel

8 Avenue Gutenberg

CS 10172 Bussy Saint Georges

F - 77607 Marne la Vallée Cedex 3

Tel.: +33 (0)1 64 76 15 00

Fax: +33 (0)1 64 76 16 99

Email: order.cryopal@airliquide.com or maintenance.cryopal@airliquide.com

Website: <http://www.cryopal.com>

Table of contents

Table of contents

1. IDENTITY OF MANUFACTURER	4
2. SAFETY INFORMATION	4
2.1. GENERAL INSTRUCTIONS	4
2.2. WARNINGS RELATED TO ELECTROMAGNETIC INTERFERENCE	5
2.3. OXYGEN-RELATED WARNINGS	5
2.4. DESCRIPTION OF LABELS	6
2.5. DEFINITION OF THE PICTOGRAMS	7
3. FREELOX RESERVE DEVICE	8
3.1. PRESENTATION OF THE DEVICE	8
3.2. TECHNICAL SPECIFICATIONS	9
3.3. PRESENTATION OF THE FREELOX RESERVE RANGE	10
4. USAGE INSTRUCTIONS	10
4.1. INTENDED USE	10
4.2. EXPECTED PERFORMANCE	10
4.3. DEVICE SERVICE LIFE	10
4.4. CONTRAINDICATIONS	10
4.5. POTENTIAL SIDE EFFECTS	10
5. MATERIALS USED	11
6. STORAGE AND HANDLING CONDITIONS	11
6.1. STORING THE FREELOX RESERVE	11
6.2. HANDLING THE FREELOX RESERVE	11
7. PREPARING AND STARTING UP THE FREELOX RESERVE	12
7.1. PREPARING THE EQUIPMENT	12
7.2. START-UP	12
7.3. FILLING THE PORTABLE DEVICE	13
7.4. CHECKING THE FILL LEVEL	14
7.5. CHECKING THE BATTERY	14
8. TRAVELLING WITH THE DEVICE	14
9. CLEANING AND MAINTENANCE	14
10. HELP	15
10.1. CONDENSATE COLLECTOR	15
10.2. THE DEVICE HAS TIPPED OVER	15
10.3. SPLASHES OF LIQUID OXYGEN	15
10.4. NO OXYGEN IS COMING OUT OF THE CANNULA OR MASK	15
10.5. IMPOSSIBLE TO DISCONNECT THE PORTABLE DEVICE FROM THE FREELOX RESERVE AFTER FILLING	15
10.6. LOW QUANTITY OF LIQUID OXYGEN	15
10.7. LOW BATTERY	15
10.8. WHAT TO DO IF YOUR DEVICE IS NOT WORKING	15
11. ACCESSORIES	16
12. DISPOSAL	16
12.1. FREELOX RESERVE DEVICE DISPOSAL METHOD	16
12.2. DISPOSAL METHOD FOR ACCESSORIES	16
13. INFORMATION ABOUT YOUR PRESCRIPTION	17

1. Identity of manufacturer

The manufacturer of the FREELOX RESERVE medical device is:



CryopAL

Parc Gustave Eiffel

8 Avenue Gutenberg

CS 10172 Bussy Saint Georges

F - 77607 Marne la Vallée Cedex 3

Tel.: +33 (0)1 64 76 15 00

Fax: +33 (0)1 64 76 16 99

Email: order.cryopal@airliquide.com or maintenance.cryopal@airliquide.com

Website: <http://www.cryopal.com>

2. Safety information

Before using the FREELOX RESERVE device, please read this manual and the following safety instructions carefully.

2.1. General instructions



These usage instructions must be strictly followed.

Use

The oxygen delivered by this device is intended to improve user comfort and must never be used as life support. This device is not recommended for patients who could suffer harm as a result of an interruption in their oxygen supply. Furthermore, the FREELOX RESERVE cannot be used for any purpose other than the medical usage prescribed by your doctor.

The device must be kept upright.

In the event of condensation, clean up any traces of water on the ground. Empty the FREELOX RESERVE condensate collector.

Equipment

The FREELOX RESERVE device must only be used with the accessories made available by the service provider.

Ensure that the oxygen tube is not pinched, bent or trapped on the ground by an obstacle (chair, table etc.).

The FREELOX RESERVE must only be connected to the portable tank supplied by your service provider and only when this is being filled.

Environment

The equipment must be used under normal temperature and pressure conditions (please refer to the *Storage and handling conditions* section).

Avoid all mechanical impacts, particularly those that could result in the deformation of the outer wall of the FREELOX RESERVE. At home, do not store the FREELOX RESERVE device in a passageway, for example. In the event of a severe impact, contact your service provider to check the integrity of your device.

The device is classified **IPX2** (degree of protection against dripping water such as rain). It is therefore prohibited to place the FREELOX RESERVE directly under water.

The operation of the level gauge may be affected by the use of devices such as mobile phones, credit card terminals, microwave ovens or defibrillators in the vicinity, or more generally by interference.

This device is not MRI-compatible. Do not enter an MRI room with your FREELOX RESERVE.

Maintenance

The handling operations authorised are those described in this manual. Maintenance operations may only be carried out by your service provider (trained, authorised staff).

It is prohibited to modify or service the unit. Only trained and qualified personnel are permitted to service this device.

It is strictly forbidden to carry out servicing and maintenance operations on the device when it is being used.

2.2. Warnings related to electromagnetic interference

In order to avoid any risk of interaction with electromagnetic fields that could interfere with the operation of other devices, tests were performed in accordance with the 60601-1-2: 2014 (version 4) standard and the appropriate modifications made. However, other devices may interfere with the operation of the FREELOX RESERVE's level gauge and vice versa. We therefore advise you to comply with the installation instructions and the precautions to be taken with regard to the electromagnetic compatibility defined in this section.

Important: Medical electrical equipment and systems should not be used or stored with other equipment. If they have to be stored or used in close proximity to other equipment, it is necessary to check that they operate normally in the configuration in which they will be used.

To avoid any risk of potential interference, do not place the device near any other electrical appliance, such as an oven, electric heater, tablet, etc.

Avoid using this appliance near other electronic devices, since this may cause the level gauge or the other devices to malfunction. If this type of use is necessary, the appliances should be observed, to check that they are operating normally.

Although this device complies with the 60601-1-2: 2014 (version 4) standard, a significant electromagnetic disturbance could temporarily disrupt the proper operation of its level gauge and compromise the reading of the device's fill level.

The use of accessories, transducers and cables other than those specified or supplied by the manufacturer of this device may cause an increase in electromagnetic emissions or a reduction in the immunity of this device and may cause the level gauge to function inappropriately.

Do not use RF portable communication devices (including peripherals such as antenna cables and external antennas) closer than 30 cm (12 inches) from any part of the FREELOX RESERVE, including the cables specified by the manufacturer. Otherwise, the performance of these devices could be impaired.

For further technical details regarding electromagnetic interference, please contact your service provider.

2.3. Oxygen-related warnings

Risk of an oxygen-rich atmosphere

The system must be placed in a ventilated room to avoid the accumulation of oxygen. Never block the air vents. Do not place on an absorbent surface (such as a carpet or rug). Do not store in a confined space. Do not cover with fabric.

The FREELOX RESERVE's flow rate selector button must be in the "0" position when not in use. It must be easily accessible at all times.

In the event of liquid oxygen splashes, change your clothes.

Fire risk

Keep the device at least 20 cm away from any electrical appliances likely to emit heat or sparks.

Keep the device at least 3 m away from flames and any appliance that may contain flames (be careful of ovens, water heaters, stoves, candles, etc.).

To prevent any risk of fire, the FREELOX RESERVE should be placed at least 1.5 m away from inflammable products such as oil, grease, face creams, solvents or aerosol sprays.

Never lubricate the components of this device.

Smoking is prohibited near the FREELOX RESERVE.

Note: Oxygen is not a flammable gas, but it does accelerate material combustion.

Risk of cryogenic burns

Do not touch the liquid oxygen or any part of the device that may have been in contact with the liquid oxygen, since liquid oxygen is extremely cold (-183°C). When the level gauge indicates that the device is empty, it may still contain oxygen (risk of cold burns).

When filling your portable device, it is advisable to wear cryogenic gloves, long sleeves, protective goggles and closed shoes to avoid any risk of cryogenic burns.

2.4. Description of labels

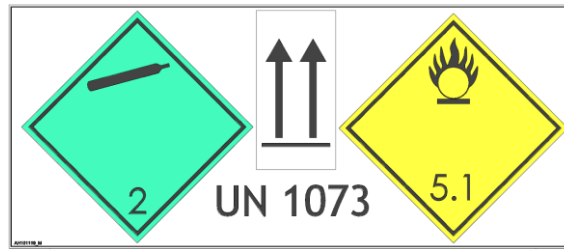

Labels found on the body of the FREELOX RESERVE



Label found near the FREELOX RESERVE's user supply point





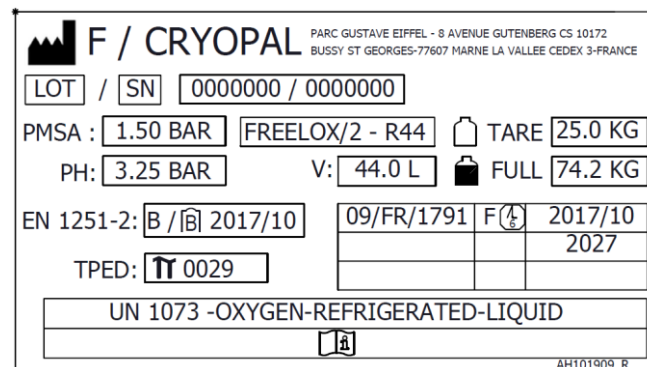















Label found on the body of the FREELOX RESERVE



Engraving found on the body of the FREELOX RESERVE

2.5. Definition of the pictograms

	Manufacturer		Category 2 gas
	BF applied part (degree of electrical protection)		Oxidising material
	Please refer to the instructions in the manual	UN 1073	Refrigerated liquid oxygen
	Waste from electrical and electronic equipment		Warning: low temperature
IPX2	Protection against dripping water		Warning
CE	CE marking, compliance with Directive 93/42/EC		Smoking prohibited
Π	Pi marking, compliance with Directive 2010/35/EC		Position the product upright
	Naked flames prohibited		Do not lubricate
	Do not touch frosted parts		Ventilate the room
	Temperature limits for using the device		Humidity limits for using the device
	Pressure limits for using the device	REF	Product reference code
SN	Serial number		Date of manufacture
	Push-button in the "on" position		

3. FREELOX RESERVE device

3.1. Presentation of the device

The home liquid oxygen system is a stationary oxygen tank (FREELOX RESERVE) that can be fitted with a small portable oxygen tank (for example, FREELOX PORTABLE). These are designed to store oxygen in its liquid state at a temperature of -183°C (liquid oxygen is a cryogenic fluid).

The FREELOX RESERVE device is a pressurised liquid oxygen tank (20L, 32L or 44L). It is used to continuously deliver a flow rate of gaseous oxygen to a patient.

FREELOX RESERVE device

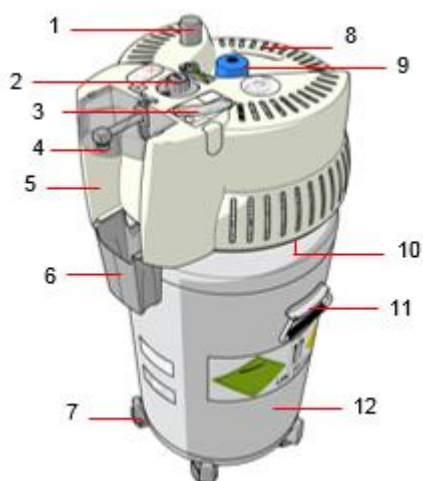

- 1: Portable tank ejection button
- 2: Flow rate selector button
- 3: Level gauge
- 4: BF applied part : oxygen outlet to the patient (outlet nozzle provided, humidifier not provided)
- 5: Location reserved for the humidifier
- 6: Water condensate collector container
- 7: Roller base
- 8: Portable tank filling base
- 9: Filling connector
- 10: Hand-hold
- 11: Handle
- 12: Stationary tank - 20, 32 or 44 litres

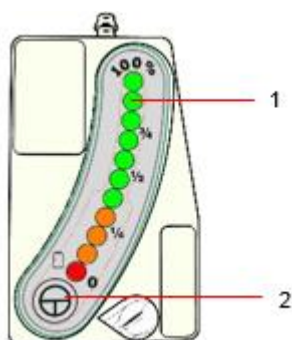

- 1: Indicator light (showing the liquid oxygen level)
- 2: Display button

3.2. Technical specifications

Model	FREELOX 20L	FREELOX 32L	FREELOX 44L
Medical indication	Oxygen therapy for patients suffering from conditions such as Chronic Obstructive Pulmonary Disease (COPD), heart failure, pulmonary hypertension		
Medical contraindications	Not recommended for life support		
Performance	Delivers oxygen at the flow rate prescribed by the doctor		
Substance transported	Medical liquid oxygen		
Tank material	Stainless steel (tanks), aluminium alloys (customer station).	Stainless steel (tanks), aluminium alloys (customer station).	Stainless steel (tanks), aluminium alloys (customer station).
Total capacity (L)	20	32	44
Height (mm)	677	817	957
Total width (mm)	430	430	430
Diameter (mm)	363	363	363
Max pressure (bar)	1.5	1.5	1.5
Normal pressure (bar)	1.35	1.35	1.35
Weight when empty (kg)	17.2	20.8	24.4
Weight when full (kg)	39.6	56.6	73.6
Evaporation (in L of liquid/day)	<0.7	<0.7	<0.7
Autonomy 24 hrs a day at 2L/min (days)	5	7	11
Flow rate range (L/min)	0 to 6	0 to 6	0 to 6
Materials in direct or indirect contact with the user	Polycarbonate, stainless steel, aluminium alloys, brass		

Table 1: Technical characteristics of the FREELOX RESERVE

Autonomy (*)			
Flow rates (L/min) +/- 10%	FREELOX RESERVE		
	20 L	32 L	44 L
0.25	25 days	40 days	50 days
0.5	19 days	30 days	38 days
0.75	12 days	22 days	28 days
1	10 days	15 days	20 days
1.5	7 days	10 days	14 days
2	5 days	7 days	11 days
2.5	4 days	6.5 days	8 days
3	3 days	5.5 days	7 days
4	2.5 days	4 days	5.5 days
5	2 days	3 days	4.5 days
6	1.5 days	2.5 days	3.5 days

Table 2: Autonomy of the FREELOX RESERVE

(*) FREELOX RESERVE filled to 100%. These figures are given for information purposes only.

3.3. Presentation of the FREELOX RESERVE range

Connection	Size	Product codes	Name
CE/STD	20 L	LF109401	FREELOX RESERVE 20L STD
CE/STD	44 L	LF105200	FREELOX RESERVE 44L-STD-BRAZIL ⁽²⁾
CE/STD	32 L	LF135700	FREELOX RESERVE 32L-STD-IT ⁽¹⁾
CE/STD	44 L	LF135800	FREELOX RESERVE 44L-STD-IT ⁽¹⁾
US	20 L	LF122701	FREELOX RESERVE 20L US
US	32 L	LF107201	FREELOX RESERVE 32L US
US	44 L	LF107300	FREELOX RESERVE 44L-US
CE/STD	32 L	LF105101	FREELOX RESERVE 32L STD-BRAZIL ⁽²⁾
US	44 L	LF107301	FREELOX RESERVE 44L-US-HUL ⁽³⁾
CE/STD	32 L	LF135200	FREELOX RESERVE 32L-STD-WO/BATTERY ⁽⁴⁾
CE/STD	44 L	LF135300	FREELOX RESERVE 44L-STD-WO/BATTERY ⁽⁴⁾
CE/STD	32L	LF105102	FREELOX RESERVE 32L STD
CE/STD	44L	LF105201	FREELOX RESERVE 44 L STD

Table 3: Product codes for the FREELOX RESERVE range

- (1): special case for Italy, use of a double barcode for these product codes
(2): special case for the Brazilian market, addition of a distributor label on the packaging
(3): special case of the client name with “Heinen und Lowenstein” label
(4): special case for South America, delivered without battery

4. Usage instructions

4.1. Intended use

The FREELOX independent oxygen therapy system is designed to supply medical oxygen to adults and children at a flow rate that can be adjusted in accordance with the medical prescription. It is only to be used under medical supervision. The system is designed to be used both in the home and in hospitals. Based on the principle of the regulated evaporation of liquid oxygen, the FREELOX system provides gaseous oxygen for medical use at a temperature close to the ambient temperature, at a constant, adjustable flow rate, from liquid oxygen stored in insulated tanks of various capacities.

4.2. Expected performance

The performance expected of the device is to deliver oxygen to the patient at a constant flow rate, in accordance with the prescriptions recommended by the doctor.

4.3. Device service life

The FREELOX RESERVE device has a service life of 10 years, with an inspection of the relief valves after 5 years.

4.4. Contraindications

Anyone who does not have a medical prescription requiring oxygen therapy treatment.
The use of the FREELOX RESERVE oxygen therapy system is not recommended for life support.

4.5. Potential side effects

Side effects observed:

- Hypercapnia (excessive carbon dioxide levels in the blood plasma)
- Burns or fire
- Dryness of the nasal and/or eye mucous membranes

5. Materials used

Materials in direct or indirect contact with the user	Polycarbonate, stainless steel, aluminium alloys, brass
--	---

Table 4: Materials that make up the FREELOX RESERVE device

6. Storage and handling conditions

6.1. Storing the FREELOX RESERVE

The FREELOX PORTABLE device must be stored in an upright position. Storage in any other position may damage the device.



The device must be kept upright.

Do not store in a confined space. Do not cover with fabric.

- Ambient temperature: -40°C to 70°C
- Relative humidity: 0% to 95% without condensation
- Atmospheric pressure: 700hPa to 1,060hPa

6.2. Handling the FREELOX RESERVE

Liquid oxygen is stored at -183°C, so it is very cold. It is essential to comply with the following safety measures:

Safety measures

Never touch the cold or frosted parts of the device. Liquid oxygen and its vapours are extremely cold: risk of frostbite (lesions identical to burns).

The FREELOX RESERVE must always be in an upright position and in a ventilated room or area. The device will continuously release gaseous oxygen even when not in service.

Do not place the equipment near a source of heat and please refer to section 2.

Never modify the equipment. For further information, please contact your service provider.

When filling your portable device, you are advised to wear cryogenic gloves, long sleeves, protective goggles and closed shoes to avoid any risk of cryogenic burns.

What to do in the event of an incident

In the eyes: wash with plenty of warm water for at least 15 minutes, then call a doctor.

On the skin: Do not rub and wash thoroughly. Remove or loosen clothing if necessary. Defrost the affected areas by heating moderately (with warm water, for example) then call a doctor.

Climatic conditions

Operating temperature: +10°C to 40°C

Operating relative humidity: 30 to 75%

Operating atmospheric pressure: 700 to 1,060 hPa

7. Preparing and starting up the FREELOX RESERVE

7.1. Preparing the equipment

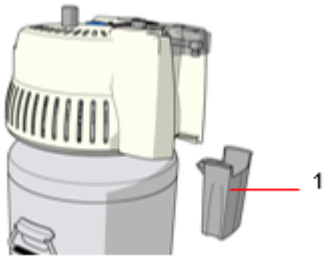

Check that the condensate collector (1) is empty and clean and then put it back in place.

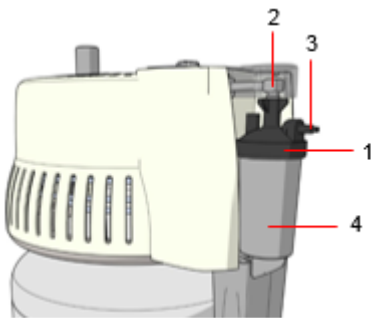

Without humidifier

Connect the oxygen tube to the FREELOX RESERVE's outlet nozzle (2).

With humidifier

Unscrew the humidifier bottle (4) and fill it with soft water, without exceeding the "max" level.

Screw the bottle (4) back onto the cover of the humidifier (1), and screw the assembly onto the FREELOX RESERVE's oxygen outlet connection (2).

Connect the oxygen tube to the humidifier's outlet nozzle (3).



Screw your humidifier on correctly, in order to avoid any risk of flow rate loss. Check that the seal of your humidifier is correctly positioned and in good condition. If this is not the case, please contact your service provider. The use of a humidifier may be recommended by your doctor to prevent irritation of the nasal mucous membranes.

7.2. Start-up

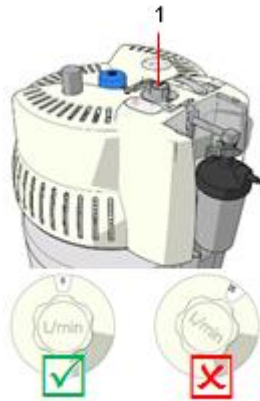

Adjust the oxygen flow rate (1) to the value prescribed by your doctor, by turning the selector button clockwise.

Warning: no oxygen is supplied if the flow rate valve is positioned between two numbers (X)!

Before positioning the oxygen tube, check that the oxygen is correctly supplied. If the FREELOX RESERVE is being used with a humidifier, check that there is a regular stream of bubbles in the humidifier.

Put the oxygen tube in place and adjust the nasal cannula on your face.

After you have finished using your device, stop the unit by turning the flow rate selector button to "0".

7.3. Filling the portable device

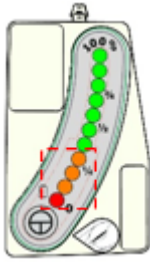

Check that the remaining oxygen level shown on the FREELOX RESERVE's level gauge is greater than or equal to 1/4. If the level is lower than 1/4, **do not fill** the portable device, in order to avoid any problems related to the filling of the portable device.

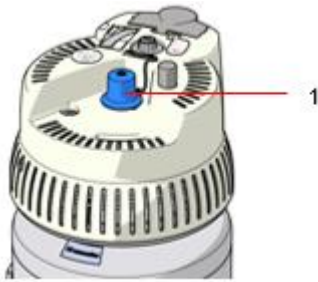

If the oxygen level is satisfactory, remove the protective cap (1) from the FREELOX RESERVE's connector.



Eliminate any traces of moisture on the filling connectors of the FREELOX RESERVE and the portable device using a **clean, lint-free cotton cloth** (moisture leads to the formation of frost on the connectors and can cause oxygen leaks).

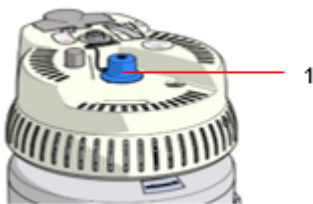

Once you have finished filling your portable device, put the protective cap back in place on the FREELOX RESERVE's filling connector.



Warning: after disconnection, do not touch any cold or frosted parts (the connectors on the stationary tank or the portable tank).



In the event of a liquid oxygen leak after the disconnection of the portable device, reconnect the two tanks immediately. After a few seconds, separate them again. If the leak persists, reconnect them and ask the service provider to service the unit. Never attempt to stop a leak by pouring water onto the FREELOX RESERVE's filling connector.

7.4. Checking the fill level

On the FREELOX RESERVE's level gauge, carry out a daily check to ensure that the FREELOX RESERVE contains enough oxygen. If this is not the case, please contact your service provider. An orange indicator light signifies that a sufficient quantity of oxygen remains available, so there is no need for an emergency call to the service provider.

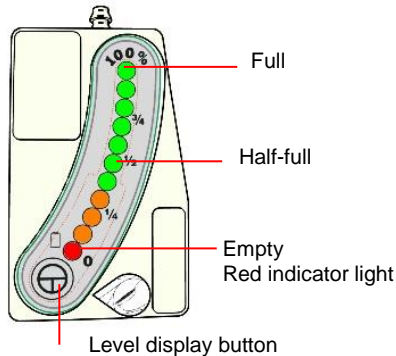

Using the level gauge, check the fill level of the FREELOX

RESERVE, by pressing the display button  for at least two seconds to display the remaining oxygen level.

- A display in the orange area indicates a sufficient quantity of oxygen, so there is no need for an emergency call to the service provider.

- A display in the red area indicates an insufficient quantity of oxygen, and an **immediate call to the service provider is necessary**.

The oxygen level shown on the gauge will be incorrect if the device is in a tilted position; it must always be used in an upright position.

7.5. Checking the battery

Press the display button  for at least two seconds to display the level remaining. The red indicator light shows how much battery charge remains or the level gauge's operating status:

- - Steady red light: acceptable battery charge.
- Rapidly flashing red light (5 times/sec): notify your service provider in order to have the battery replaced during the next oxygen filling operation.
- Slowly flashing red light (2 times/sec): gauge not working. **Contact your service provider.**
- Display off: battery dead.

8. Travelling with the device

The FREELOX RESERVE device cannot be moved outside the living area room; you will have defined this room beforehand with your service provider. It cannot be taken outside your home.

The FREELOX RESERVE must only be moved on level ground. Under no circumstances should it be carried on stairs or over door sills, for example.

9. Cleaning and maintenance

- Regularly empty out any condensation water that has collected in the condensate collector located in front of the FREELOX RESERVE, just under the grey cover. To remove this container, pull it forwards. Clean and rinse it before putting it back in place. It can also be cleaned in a dishwasher.
- Clean the humidifier once a week using soapy water (such as washing up liquid). Rinse it thoroughly in clean water. Change the water in the humidifier every day. Use soft water.
- Check the level every day. If it is less than 1/4 and if a delivery is not planned within the next 24 hours, contact your service provider.
- Before using your FREELOX RESERVE, check that the level gauge is working properly and check the battery charge level (section 7.5). After each complete fill of your FREELOX RESERVE, check that the level gauge correctly displays the maximum fill level. In order to maintain the effectiveness of the shielding and the masses, check that the level gauge is working properly before each use.
- When the location of use is close to AM, FM or broadcasting antennas, the procedures described earlier in this section must have been complied with as a preventive measure.
- With the exception of the connectors, you can clean the FREELOX RESERVE using a damp, non-abrasive sponge (do not use abrasive powder).



The use of acetone, solvents or any other flammable substances is prohibited.

10. Help

If you have a problem with your FREELOX RESERVE device, please contact your service provider.

10.1. Condensate collector

If the condensate collector is full, please refer to the *Preparing the equipment* section.

10.2. The device has tipped over

Immediately return the FREELOX RESERVE to its upright position. Be careful not to touch the liquid oxygen or any cold parts, ventilate the area and leave the room for 1 to 2 hours.

10.3. Splashes of liquid oxygen

In the eyes: wash with plenty of warm water for at least 15 minutes, then call a doctor.

On the skin: Do not rub and wash thoroughly. Remove or loosen clothing if necessary. Defrost the affected areas by heating moderately (with warm water, for example) then call a doctor.

10.4. No oxygen is coming out of the cannula or mask

Check the FREELOX RESERVE's fill level.

Check that the flow rate selector is in the correct position.

Disconnect and reconnect the tube, cannula or mask.

Check the accessories: for example, bent, trapped or punctured tubing.

10.5. Impossible to disconnect the portable device from the FREELOX RESERVE after filling

Use the FREELOX RESERVE's ejection system. If this does not suffice, wait a few minutes and then try to disconnect the portable device again using a rotating movement. As a preventive measure, dry the connectors before connection and put the cap back on.

10.6. Low quantity of liquid oxygen

Flow rate adjustment button not correctly positioned	Turn the button to the correct position.
Defective tubing	Disconnect the tubing. If the flow rate is re-established, check the tubing (leak, bend or obstruction). Replace it if necessary.
Oxygen delivery device (cannula, etc.) defective	Disconnect the delivery device from the tubing. If the flow rate is re-established, check the delivery device, and where necessary, its connection to the extension. Replace it if necessary.
System empty	Check the level. If the FREELOX RESERVE is empty, call your service provider.
Humidifier (or supply point with outlet nozzle) obstructed or leaking	Unscrew the humidifier (or the supply point with outlet nozzle). If the flow rate is re-established, check that it is not obstructed or leaking. Check that the humidifier's seal is correctly positioned and in good condition. Manually tighten the humidifier container correctly.

Table 5: Defects that can lead to low oxygen output

10.7. Low battery

Contact your service provider.

10.8. What to do if your device is not working

If your FREELOX RESERVE device is still not working:

- Do not panic
- Connect your nasal cannula to a back-up tank, if this is available.
- Contact your service provider immediately. Their contact details can usually be found in section 13.

11. Accessories



Only Cryopal accessories are approved for use with our devices. The use of different accessories may affect the safety of this medical device, and releases Cryopal from all liability in the event of an incident. The device is no longer covered by its warranty if different accessories are used.

The following accessories are available with your FREELOX RESERVE device:



Roller base (class I
medical device)
Product code LF 147000



Adult oxygen cannula with
curved supply points and
2m tube (class IIa medical
device)
Product code LF121100



4m oxygen tube (class IIa
medical device)
Product code LF121300



10m oxygen tube (class IIa
medical device)
Product code LF121500



15m oxygen tube (class IIa
medical device)
Product code LF121600



Humidifier (class IIa
medical device)
Product code LF122200



High flow rate humidifier
(class IIa medical device)
Product code LF122000

12. Disposal

12.1. FREELOX RESERVE device disposal method

You must never dispose of the FREELOX RESERVE device with your household waste. If your FREELOX RESERVE device is not working or you are not satisfied with it, or for any other reason that could make you want to dispose of your device, it must be handed back to your service provider, who will dispose of it in accordance with the 2012/19/EU WEEE Directive.

12.2. Disposal method for accessories

All waste generated by the use of the *FREELOX* system (oxygen cannula, base, battery, etc.) must be disposed of through the appropriate waste treatment channels in accordance with the regulations in force. If in doubt, contact your service provider.

13. Information about your prescription

The **FREELOX** oxygen therapy system delivers the medical oxygen flow rate prescribed by your doctor. It was designed and manufactured by CRYOPAL in Bussy Saint Georges, France. It has been given to you by your service provider, whose address is provided below. It comprises a stationary tank and a portable tank, which you can fill from the stationary tank for use when travelling. If you have any questions, please contact your service provider.

If any type of malfunction occurs, only your service provider is qualified to service the system.

When you call, please state:

Service provider stamp

Your name:

Your town/city:

Your telephone number:

Your reference number:

Numbers to call

- For all information during working hours:

Tel.:

- For any technical emergency, 24/7:

Tel.:

Your medical contacts

Your attending
physician:

Dr.

Tel.:

Your pulmonologist:

Dr.

Tel.:

Prescribed oxygen flow rates

At rest:

Litres/minute

Upon exertion:

Litres/minute

Note

Note

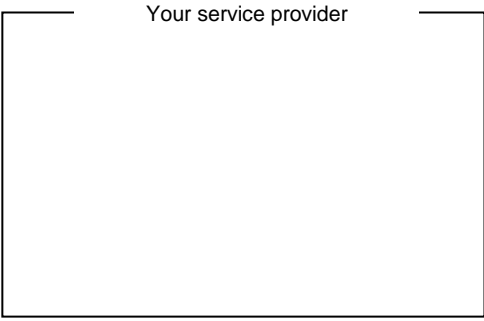

www.cryopal.com

NH78459-EN_E